

The Waltham VFW Post #2152

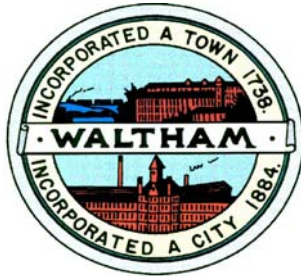

**Invites
Interested Parties
To propose the best offer and or bid
For the service or product herewith described:**

WALTHAM VFW RENOVATION

The bid opening will be held: Friday February 8, 2013 at 10:00 AM

**Site Inspection and Tour will be held: Tuesday January 29, 2013 at 10 AM
(meet at VFW Post #2152, 210 Felton Street, Waltham, MA 02453)**

Table of Contents:

- **Invitation to Bid**
- **Intent of the Project**
- **Agreement**
- **Instructions**
- **General Conditions**
- **Specifications**
- **Compliance**
- **Bid Price**

Invitation to Bid

The Waltham VFW Post #2152

REQUEST FOR BID (RFB)

Under the rules of M.G.L. Chapter 149, Gerry Lyons, Commander of the Post, hereby requests sealed bids for:

Waltham VFW Renovations

Price Proposals will be received at the office of the VFW Post #2152, 210 Felton Street, Waltham MA 02452, until,

Friday February 8, 2013 at 10 AM

At which time and place the bids will be publicly opened and read.

Specifications and information available online by visiting the Waltham Purchasing Department web site at www.city.waltham.ma.us/open-bids

BIDS MUST BE SIGNED AND ENCLOSED IN A SEALED ENVELOPE AND MARKED:

BID FOR: Waltham VFW Renovations

If the Bidder is a corporation, state your correct corporate name and State of incorporation. If Bidder is a partnership, state names and addresses of partners. If Bidder is a trust or other legal entity, state correct names and addresses of trustees or names and address of those legally authorized to bid and enter into contracts.

EXCEPTION OR ALTERNATES TO SPECIFICATIONS, TERMS OF SALE, AND DISCOUNTS AVAILABLE, MUST BE INCLUDED IN THE BID PRIOR TO OPENING DATE.

Intent of Project

Project consists of ADA upgrades to the Felton Street exterior of the building, a chair lift on the Felton St side, and a new bathroom for the purposes of complying with ADA regulations.

The exterior improvements will consist of a new entry canopy to enclose a Garavanta Stair Lift Xpress II (tower mount). The canopy will be weatherproof but not heated. Electricity will be provided for the lift and interior (porch) for use of the lift and the existing stairs to the Felton Street entry of the building. The new bathroom will be converted from an existing storage closet and be situated adjacent to the existing bathrooms.

AGREEMENT

ARTICLE 1. This agreement, made this _____ day of _____, 2013 by and between the WALTHAM VFW POST NUMBER 2152, party of the first part, hereinafter called the POST, by its COMMANDER OF THE POST, and

hereinafter called the CONTRACTOR.

ARTICLE 2. Witnesseth, that the parties to this agreement, each in consideration of the agreement on the part of the others herein contained, do hereby agree, the POST for itself, and said contractor for his heirs, executors, administrators and assigns as follows:

To furnish all equipment, machinery, tools and labor, to furnish and deliver all materials required to be furnished (except as otherwise specified) and deliver in and about the project and to do and perform all work in strict conformity with the provisions of this Contract and of the Notice to Bidders, bid, Project Manual, and Drawings hereto annexed. The said Notice to Bidders, bid, Project Manual, and Drawings are hereby made a part of this contract as fully and to the same effect as if the same had been set forth at length and incorporated in the contracts.

ARTICLE 3. In consideration of the foregoing premises the POST agrees to pay and the CONTRACTOR agrees to receive as full compensation for everything furnished and done by the CONTRACTOR under this contract, including all work required by not included in the items herein mentioned, and also for all loss or damage arising out of the nature of the work aforesaid, or from the action of the elements, or from any unforeseen obstruction or difficulty encountered in the prosecution of the work, and for all expenses incurred by or in consequence of the suspension or discontinuance of the work specified, and for well and faithfully completing the work, and the whole thereof, as herein provided, such prices as are set forth in the accompanying bid.

This Agreement entered into as of the day and year first written above.

VFW POST #2152, MASSACHUSETTS

FOR THE POST

Gerry Lyons, Commander of the Post,
VFW POST #2152
Date: _____

FOR THE COMPANY

CONTRACTOR (Signature),
Date: _____

Company

Address

Instructions

INSTRUCTIONS FOR BIDDERS

1. **READ ALL DOCUMENTS.**

Bidders should familiarize themselves with all the documents contained herein; it is mandatory that all Bids be in compliance with all the provisions contained in said documents.

2. **FORMS AND ATTACHMENTS.**

Bids are to be completed on the forms provided ONLY and enclosed in a sealed envelope marked on the outside "BID (title)" and the name and address of bidder. Attachments submitted in addition to the POST produced forms may not be considered.

3. **PRINTED OR TYPED RESPONSE.**

All information must be typewritten or printed in ink, including the price the bidder offers in the space as provided on the bid form.

4. **CORRECTIONS.**

Bids that are submitted containing cross outs, white outs or erasures, will be rejected. All corrections or modifications to the original bid are to be submitted in a separate envelope, properly marked on the outside, "CORRECTION/ MODIFICATION TO BID (title)" and submitted prior to the bid opening.

ALL DOCUMENTS SUBMITTED WITH YOUR RESPONSE WILL BE INCORPORATED INTO THE CONTRACT.

5. **PRICE IS ALL INCLUSIVE.**

Bid prices shall encompass everything necessary for furnishing all items, materials, supplies or services as specified, and in accordance with the specifications, including proper packing, cost of delivery, and in the case of services, completion of same, as per specifications.

6. **PRICE DISCREPANCY.**

In the event of a discrepancy between the Unit Price and the Extension, the Unit Price shall prevail.

7. EXPLANATIONS, EXCEPTIONS

Explanations, exceptions or other information pertinent to the specifications may be made in writing and included in the same envelope with the bid.

8. WITHDRAW.

A Bid may be withdrawn by written request prior to the schedule for the Bid Opening. No withdrawals are permitted after the bid opening date and time. Withdrawals after the bid opening date will cause the forfeit of the bid Deposit.

9. AWARD.

Bids will be awarded not later than (90) ninety days after the scheduled bid opening date, unless otherwise stated, in the specifications. Unless otherwise specified, bids will be evaluated on the basis of, completeness of your RFP response, responsiveness, responsibility, best price and experience.

10. AWARD CRITERIA.

Qualified and responsive proposals will be evaluated based on Price, Technical, and Compliance requirements:

12. DISCOUNTS.

Discounts for prompt payments will be considered when making awards.

13. TAX EXEMPT.

Purchases by the VFW POST #2152 are exempt from any Federal, State or Massachusetts Municipal Sales and/or Excise Taxes.

14. SAMPLES.

The VFW POST #2152 may require the submission of samples either before or after the awarding of a contract. Samples are to be submitted, at no charge to the POST, so as to ascertain the product's suitability. If specifically stated in the Bid that samples are required, said samples must be submitted with the Bid prior to the Official Bid Opening. Failure to submit said samples would be cause for rejection of Bid. All samples must be called for and picked up within (30) thirty days of award or said samples will be presumed abandoned and will be disposed of.

15. ACTIVE VENDOR LIST.

Vendors who wish to remain on the Active Bid List must either submit a Bid, No Bid, or a letter requesting same, no later than the Official Bid Opening. This is applicable to those vendors who have received the Invitation to Bid.

16. FUNDS APPROPRIATION.

THE CONTRACT OBLIGATION ON BEHALF OF THE POST IS SUBJECT TO PRIOR APPROPRIATION OF MONIES FROM THE FUNDING GOVERNMENTAL BODY AND AUTHORIZATION BY THE COMMANDER OF THE POST.

17. THE AWARDING AUTHORITY RESERVES THE RIGHT TO REJECT ANY OR ALL BIDS, OR ANY PART OF ANY BID, WHICH IN THE OPINION OF THE AWARDING AUTHORITY, IS IN THE BEST INTERESTS OF THE VFW POST #2152.

18. THE TAX ATTESTATION CLAUSE, CERTIFICATION OF NON-COLLUSION AND THE CERTIFICATE OF VOTE AUTHORIZATION, are required by statute and are an integral part of the Invitation for Bid and must be completed and signed by the person submitting the Bid, or by the person/persons who are officially authorized to do so. Failure to do so may disqualify the bid.

19. STANDARD OF QUALITY.

Where, in the specifications, one certain kind, type, catalog number, brand or manufacturer of material is named, it shall be regarded as the required standard of quality. Where two or more are named, these are presumed to be equal and the Bidder may select one or the other. If the Bidder proposes to offer a substitute as an equal, he shall so indicate on the Bid Form, the kind, type, catalog number, brand, or manufacturer of material that is offered as an equal, and describe where it differs from the specifications. Substituted items must be capable of performing all the functions and/or operational features described or indicated in the specifications. Failure to indicate the description of any substitute item on the Bid will be interpreted to mean that the Bidder will furnish the item or service as specified.

20. MODIFICATION.

No agreement, understanding, alteration or variation of the agreement, terms or provisions herein contained shall bind the parties, hereto unless made and executed in writing by the parties hereto.

21. ASSIGNMENT.

The final payment for work done under this Contract shall be made only after the Contractor has signed a statement under the penalty of perjury, certifying that he has completed the work described in the final estimate. Neither party hereto shall assign this Contract or sublet it in part or as a whole without the prior written consent of the other

party hereto. The Contractor shall not assign any sum or sums due or becoming due to him hereunder without the prior written consent of the POST.

22. DELIVERIES:

a) The Contractor shall pay all freight and delivery charges. The POST does not pay for shipping and packaging expenses. Items must be delivered as stipulated in the specifications. All deliveries must be made to the inside of the POST building. Sidewalk deliveries will not be accepted. POST personnel are not required to assist in the deliveries and contractors are cautioned to notify their shippers that adequate assistance must be provided at the point of delivery, when necessary.

b) All items of furniture must be delivered inside the building, set up, in place and ready for use. Deliveries are to be made between the hours of 8:30 a.m. and 3:00 p.m., Monday through Friday, except on holidays.

c) All damaged items, or items which do not comply with specifications will not be accepted and title therefore will not vest to the POST until such items are accepted and signed for, in good order, by the POST receiving department.

d) The contractor must replace, without further cost to the POST, such damaged or non-complying items before payment will be made.

23. LABELING.

All packages, cartons or other containers must be clearly marked with (a) building and room destination; (b) description of contents of item number from specifications; (c) quantity; (d) VFW POST #2152 Purchase Order Number and (e) Vendor's name and order number.

24. GUARANTEES.

Unless otherwise stipulated in the specifications, furniture, equipment and similar durable items shall be guaranteed by the contractor for a period of not less than one year from the date of delivery and acceptance by the POST receiving department. In addition, the manufacturer's guarantee shall be furnished. Any items provided under this contract, which are or become defective during the guarantee period shall be replaced by the contractor free of charge with the specific understanding that all replacements shall carry the same guarantee as the original equipment. The contractor shall make such replacement immediately upon receiving notice from the POST.

25. SINGLE VENDOR.

The POST desires to award a single contract based on the Grand Total Price. However, where applicable, the POST reserves the right to make multiple awards on a unit price basis if, in the opinion of the COMMANDER, it is in the best interest of the POST.

26. CHANGE ORDERS.

Change orders are not effective until, if, as and when signed by the COMMANDER and no work is to commence until the change orders are fully executed.

28. BID OPENING INCLEMENT WEATHER

If, at the time of the originally scheduled bid opening, the POST is closed to inclement weather or another unforeseeable event, the bid opening will be extended until 2:00 PM on the next normal business day. Bids will be accepted until that date and time.

GENERAL CONDITIONS

GENERAL CONDITIONS

1. INFORMATION

All information shall come from the Office of the POST Commander. The Contractor shall inquire at this office for any information needed. Wherever the words “or equal as approved” are used, it is to be understood that the opinion of the POST Commander shall govern.

2. SUITS

The Contractor shall assume defense of and shall indemnify and hold the POST and its agents harmless from all suits and claims against the POST and its sub-contractors arising from the use of any invention, patent right labor or employment, or from any act of omission or neglect of the POST, its agents, employees or any subcontractor in performing the work, under this contract.

3. LAWS AND REGULATIONS

The Contractor shall conform to all the applicable rules, regulations, laws and ordinances of the Commonwealth of Massachusetts, the United States of America and all agencies having jurisdiction over this contract.

4. PROTECTION OF PROPERTY

The Contractor shall take all proper precautions to protect the POST’s property from damage and unnecessary inconvenience. Any POST property damaged by the Contractor in carrying out the provisions of this contract shall be restored to its original condition, by and at the expense of the Contractor.

5. PROTECTION OF PERSONS

The Contractor shall take all proper precautions to protect persons from injury, unnecessary inconvenience, and shall be responsible for his failure to do so. The Contractor agrees to hold the POST harmless from any and all liabilities of every nature and description, which may be suffered through bodily injury, including death, to any person, by reason of negligence of the Contractor, his agents or employees, or any subcontractor.

6. CONTRACT DURATION.

This contract is for the period required to complete the project.

7. INSURANCE

A. WORKMAN'S COMPENSATION: The Contractor shall provide insurance for the payment of compensation and furnishing of other benefits under Chapter 152 of the General Laws of the Commonwealth of Massachusetts to all persons to be employed under this contract, the premiums for which shall be paid by the Contractor. Contractors shall provide insurance on a primary basis and the contractor's policy shall be exhausted before resorting to other policies. The contractor's policy is the primary one not the contributory.

B. COMPREHENSIVE GENERAL LIABILITY

Bodily Injury:	\$1,000,000 Each Occurrence
	\$2,000,000 Aggregate
Property Damage:	\$1,000,000 Each Occurrence
	\$2,000,000 Aggregate

C. AUTOMOBILE (VEHICLE) LIABILITY

Bodily Injury	\$2,000,000 Each Occurrence
Property Damage	\$1,000,000 Aggregate

D. UMBRELLA POLICY

General liability	\$1,000,000
--------------------------	--------------------

Your bid response must include a Certificate of Insurance with the above limits as a minimum. In addition, the Certificate of Insurance must have the following text contained in the bottom left box of the Certificate: **"The VFW POST #2152 is a named Additional Insured for all Insurance"**. The Certificate of Insurance must be mailed directly to:

**VFW Post #2152
210 Felton Street
Waltham, MA 02453**

A LETTER FROM A SURETY COMPANY CERTIFYING THAT THE CONTRACTOR IS QUALIFIED AND CAPABLE OF OBTAINING THE ABOVE BONDS MUST BE INCLUDED WITH HIS/HERS BID.

8. PERSONNEL:

The Contractor shall employ a competent supervisor and all properly licensed personnel necessary to perform the services required in this contract. The POST shall have the right to require the Contractor to remove and/or replace any of the personnel for nonperformance or for unprofessional behavior. The POST may require the Contractor to submit a weekly performance record of the areas and of the work performed, on forms approved by the POST. The Contractor or his supervisor shall be available to inspect such work as required by the POST.

9. PREVAILING WAGES

The Contractor is required to pay the prevailing wages as determined under the provisions of Chapter 149, Sections 26 and 27D of the Massachusetts General Laws, including the submission of weekly payrolls to the POST.

10. MATERIALS

The POST or its Agent reserves the right to approve or reject any supplies, material or equipment used by the Contractor. The Contractor agrees to replace any supplies, material or equipment used by the Contractor. The Contractor agrees to replace any rejected supplies, materials or equipment, to the satisfaction of the POST or its Agents.

11. TERMINATION OF CONTRACT

This contract may be terminated by the POST upon deliverance to the Contractor of a five-day written notice of said termination.

12. CONTRACT OBLIGATIONS

Contract obligations on behalf of the POST are subject to an annual appropriation to cover the contract obligation.

13. BIDDER EXPERIENCE EVALUATION

Each bidder shall submit with his bid, all the information relative to their experience and qualifications in performing the work required under this contract and shall have been in business for a minimum of five (5) years, in order for their bid to be considered.

15. NOT-TO-EXCEED AMOUNT

The bid amount proposed in your company's response is a "not-to-Exceed" amount unless the POST makes changes, in writing, to the scope of work to be performed.

The Change Order must be signed and approved by the Commander of the Post prior to the commencement of the change order work. No work is to begin until the proper approvals have been obtained. A change order will be priced at the unit price. Failure to comply with this procedure will result in the cancellation of the contract and the non-payment of services provided

16. FINANCIAL STATEMENTS.

The POST may require, within five (5) days after the bid opening, a complete and detailed Financial Statement prepared by a Certified Public Account, to determine a bidder's financial stability.

17 BREACH OF CONTRACT/ NON PERFORMANCE

If the Contractor shall provide services in a manner, which is not to the satisfaction of the Post, the POST may request that the Contractor refurnish services at no additional cost to the POST until approved by the POST. If the Contractor shall fail to provide services, which are satisfactory to the POST, the POST in the alternative may make any reasonable purchase or Contract to purchase services in substitution for those due from the Contractor. The POST may deduct the cost of any substitute Contract for nonperformance of services together with incidental and consequential damages from the Contract price and shall withhold such damages from sums due or to become due to the Contractor. If the damages sustained by the POST exceed sums due or to become due, the Contractor shall pay the difference to the POST upon demand. The Contractor shall not be liable for any damages sustained by the POST due to the Contractor's failure to furnish services under the terms of this Contract if such failure is in fact caused by the occurrence of a contingency the nonoccurrence of which was a basic assumption under which this Contract was made, including a state of war, embargoes, expropriation of labor strike or any unanticipated federal, state or municipal governmental regulation of order, provided that the Contractor has notified the POST in writing of such cause within seven (7) days after its occurrence.

18 RIGHT TO AUDIT

The VFW POST #2152 has the right to review and audit documents related to this contract. This right extends to any subcontractor, supplier or other entity used by the prime contractor to fulfill the obligations under this contract.

NOTE

Failure to submit any of the required documents, in this or in other sections, with your bid response package may cause the disqualification of your proposal

Specifications

Project for funding consists of ADA upgrades to the Felton Street exterior of the building, a chair lift on the Felton St side, and a new bathroom for the purposes of complying with ADA regulations.

The exterior improvements will consist of a new entry canopy to enclose a Garavanta Stair Lift Xpress II (tower mount). The canopy will be weatherproof but not heated. Electricity will be provided for the lift and interior (porch) for use of the lift and the existing stairs to the Felton Street entry of the building. The new bathroom will be converted from an existing storage closet and be situated adjacent to the existing bathrooms. SEE DRAWINGS LATER IN THIS DOCUMENT.

Compliance

(Required Documents.)

Compliance

The compliance documents in this section must be completed, signed and returned **with your bid package.**

VFW POST #2152
210 Felton Street
Waltham, MA 02453

Failure to submit the completed documents will cause the disqualification of the proposal.

Section Index

	Check when Complete
• Non-collusion form and Tax Compliance form.....	_____
• Corporation Identification Form.....	_____
• Certificate of Vote Authorization.....	_____
• Certificate of Insurance (showing all limits of WC &GL).....	_____
• Three (3) References.....	_____
• Debarment Certificate.....	_____
• Prevailing Wage Certificate.....	_____
• Right-to-know Law.....	_____

Before the commencement of the Job, the contractor must provide to the above office:

Your Company's Name: _____

Service or Product Bid _____

NOTE: Failure to submit any of the required documents, in this or in other sections, with your bid response package may cause the disqualification of your proposal.

NON-COLLUSION FORM AND TAX COMPLIANCE FORM

CERTIFICATE OF NON-COLLUSION

The undersigned certifies under penalties of perjury that this bid or proposal has been made and submitted in good faith and without collusion or fraud with any other person. As used in this certification, the word "person" shall mean any natural person, business, partnership, corporation, union, committee, club, or other organization, entity or group of individuals. The undersigned certifies that no representations made by any POST officials, employees, entity, or group of individuals other than the Commander of the Post of the VFW POST #2152 was relied upon in the making of this bid

_____, _____
(Signature of person signing bid or proposal) Date

(Name of business)

TAX COMPLIANCE CERTIFICATION

Pursuant to M.G.L. c. 62C, & 49A, I certify under the penalties of perjury that, to the best of my knowledge and belief, I am in compliance with all laws of the Commonwealth relating to taxes, reporting of employees and contractors, and withholding and remitting child support.

_____, _____
Signature of person submitting bid or proposal Date

Name of business

NOTE

Failure to submit any of the required documents, in this or in other sections, with your bid response package may cause the disqualification of your proposal.

CERTIFICATE OF VOTE OF AUTHORIZATION

Date:

I _____, Clerk of _____ hereby certify that at a meeting of the Board of Directors of said Corporation duly held on the _____ day of _____ at which time a quorum was present and voting throughout, the following vote was duly passed and is now in full force and effect:

VOTED: That _____ (*name*) is hereby authorized, directed and empowered for the name and on behalf of this Corporation to sign, seal with the corporate seal, execute, acknowledge and deliver all contracts and other obligations of this Corporation; the execution of any such contract to be valid and binding upon this Corporation for all purposes, and that this vote shall remain in full force and effect unless and until the same has been altered, amended or revoked by a subsequent vote of such directors and a certificate of such later vote attested by the Clerk of this Corporation.

I further certify that _____ is duly elected/appointed _____ of said corporation

SIGNED:

(Corporate Seal)

Clerk of the Corporation:

Print Name: _____

COMMONWEALTH OF MASSACHUSETTS

County of _____

Date:

Then personally appeared the above named and acknowledged the foregoing instrument to be their free act and deed before me, _____

Notary Public;

My Commission expires: _____

CORPORATION IDENTIFICATION

The bidder for the information of the Awarding Authority furnishes the following information.

If a Corporation:

Incorporated in what state _____

President _____

Treasurer _____

Secretary _____

Federal ID Number _____

If a foreign (out of State) Corporation – Are you registered to do business in Massachusetts?

Yes _____, No _____

If you are selected for this work you are required under M.G.L.ch. 30S, 39L to obtain from the Secretary of State, Foreign Corp. Section, State House, Boston, a certificate stating that you Corporation is registered, and furnish said certificate to the Awarding Authority prior to the award.

If a Partnership: (Name all partners)

Name of partner _____

Residence _____

Name of partner _____

Residence _____

If an Individual:

Name _____

Residence _____

If an Individual doing business under a firm's name:

Name of Firm _____

Name of Individual _____

Business Address _____

Residence _____

Date _____

Name of Bidder _____

By _____

Signature

Title

Business Address

(POST OFFICE BOX NUMBER NOT ACCEPTABLE)

City

State

Telephone Number

Today's Date

PROVIDE THREE (3) SERVICE APPROPRIATE REFERENCES

1. Company Name:

Address:

Contact Name:

Phone #

Type of service/product provided to this Company:

Dollar value of service provided to this Company:

2. Company Name:

Address:

Contact Name:

Phone #

Type of service/product provided to this Company:

Dollar value of service provided to this Company:

3. Company Name:

Address:

Contact Name:

Phone #

Type of service/product provided to this Company:

Dollar value of service provided to this Company:

NOTE

Failure to submit any of the required documents, in this or in other sections, with your bid response package will be cause for the disqualification of your company.

**WEEKLY PAYROLL RECORDS REPORT &
STATEMENT OF COMPLIANCE**

In accordance with Massachusetts General Law c. 149, §27B, a true and accurate record must be kept of all persons employed on the public works project for which the enclosed rates have been provided, A Payroll Form has been printed on the reverse of this page and includes all the information required to be kept by law. Every contractor or subcontractor is required to keep these records and preserve them for a period of three years from the date of completion of the contract.

In addition, every contractor and subcontractor is required to submit, on a weekly basis, a copy of his or her weekly payroll records to the awarding authority. For every week in which an apprentice is employed, a photocopy of the apprentice's identification card must be attached to the payroll report. Once collected, the awarding authority is also required to preserve those reports for three years.

In addition, each such contractor, subcontractor, or public body shall furnish to the awarding authority directly, within fifteen days after completion of its portion of the work, a statement, executed by the contractor, subcontractor or public body who supervises the payment of wages, in the following form:

STATEMENT OF COMPLIANCE

_____, 200_____

I _____, _____
(Name of signatory party) (Title)

I do hereby state that I pay or supervise the payment of the persons employed by

_____ on the _____
(Contractor, subcontractor or public body) (Building or project)

and that all mechanics and apprentices, teamsters, chauffeurs and laborers employed on said project have been paid in accordance with wages determined under the provisions of sections twenty-six and twenty-seven of chapter one hundred and forty nine of the General Laws.

Signature _____, Title _____

WEEKLY PAYROLL REPORT FORM

Company Name: _____
 Project Name: _____
 Awarding Auth.: _____
 Work Week Ending: _____

Prime Contractor
 Subcontractor
 List Prime Contractor: _____
 Employer Signature: _____
 Print Name & Title: _____

Final Report

Employee Name & Address	Work Classification	(A) Hours Worked							(B) Hourly Base Wage	Employer Contributions			(F) [B+C+D+E] Hourly Total Wage (prev. wage)	(G) [A*F] Weekly Total Amount		
		S	M	T	W	T	F	S		(C) Health & Welfare	(D) Pension	(E) Supp. Unemp.				
															Tot. Hrs.	

NOTE: Every contractor and subcontractor is required to submit a copy of their weekly payroll records to the awarding authority.

RIGHT TO KNOW LAW

Any vendor who receives an order or orders resulting from this invitation agrees to submit a Material Safety Data Sheet (MSDS) for each toxic or hazardous substance or mixture containing such substance, pursuant to M.G.L. c. 111F, §§8,9 and 10 and the regulations contained in 441 CMR 21.06 when deliveries are made. The vendor agrees to deliver all containers properly labeled pursuant to M.G.L. c. 111F §7 and regulations contained in 441 CMR 21.05. Failure to furnish MSDS and/or labels on each container may result in civil or criminal penalties, including bid debarment and action to prevent the vendor from selling said substances, or mixtures containing said substances within the Commonwealth. All vendors furnishing substances or mixtures subject to Chapter 111F or M.G.L. are cautioned to obtain and read the laws, rules and regulations referenced above. Copies may be obtained from the State House Bookstore, Secretary of State, State House, Room 117, Boston, MA (617) 727-2834.

Authorized Signature Indicating Compliance with the Right-to-know laws:

Signature

Date

Print Name

NOTE

Failure to submit any of the required documents, in this or in other sections, with your bid response package may cause the disqualification of your proposal.

DEBARMENT CERTIFICATION

In connection with this bid and all procurement transactions, by signature thereon, the respondent certifies that neither the company nor its principals are suspended, debarred, proposed for debarment, declared ineligible, or voluntarily excluded from the award of contracts, procurement or non procurement programs from the Commonwealth of Massachusetts, the US Federal Government and /or the VFW POST #2152. "Principals" means officers, directors, owners, partners and persons having primary interest, management or supervisory responsibilities with the business entity. Vendors shall provide immediate written notification to the Commander of the Post of the VFW POST #2152 at any time during the period of the contract of prior to the contract award if the vendor learns of any changed condition with regards to the debarment of the company or its officers. This certification is a material representation of fact upon which reliance will be placed when making the business award. If at any time it is determined that the vendor knowingly misrepresented this certification, in addition to other legal remedies available to the VFW POST #2152, the contract will be cancelled and the award revoked.

Company Name _____

Address _____

City _____, State _____, Zip Code _____

Phone Number (____) _____

E-Mail Address _____

Signed by Authorized Company Representative:

Print name _____

Date _____

10 HOURS OSHA TRAINING CONFIRMATION

Chapter 306 of the Acts of 2004

CONSTRUCTION PROJECTS

AN ACT RELATIVE TO THE HEALTH AND SAFETY ON PUBLIC

The undersigned hereby certifies that all employees to be employed at a worksite for construction, reconstruction, alteration, remodeling, repair, installation, demolition, maintenance or repair of any public work or any public building estimated to cost more than \$10,000.00 have successfully completed a course in construction safety and health approved by the **United States Occupational Safety and Health Administration** that is at least **10 hours** in duration at the time the employee begins work and who shall furnish documentation of successful completion of said course with the first payroll report for each employee and will comply with all laws and regulations applicable to awards of subcontracts subject to section 44F.

Company Name: _____

Address: _____

Signature: _____

Title: _____

Print Name _____

Date

See Chapter 306 of the Acts of 2004

NOTE

Failure to submit any of the required documents, in this or in other sections, with your bid response package will be cause for the disqualification of your company.

BID PRICE FORM

In response to the enclosed solicitation my company offers the price of
\$ _____ to fully complete the work specified within this document.

Company: _____

Authorized Signature: _____

Print Title: _____

Date: _____

PRINTS/DRAWINGS

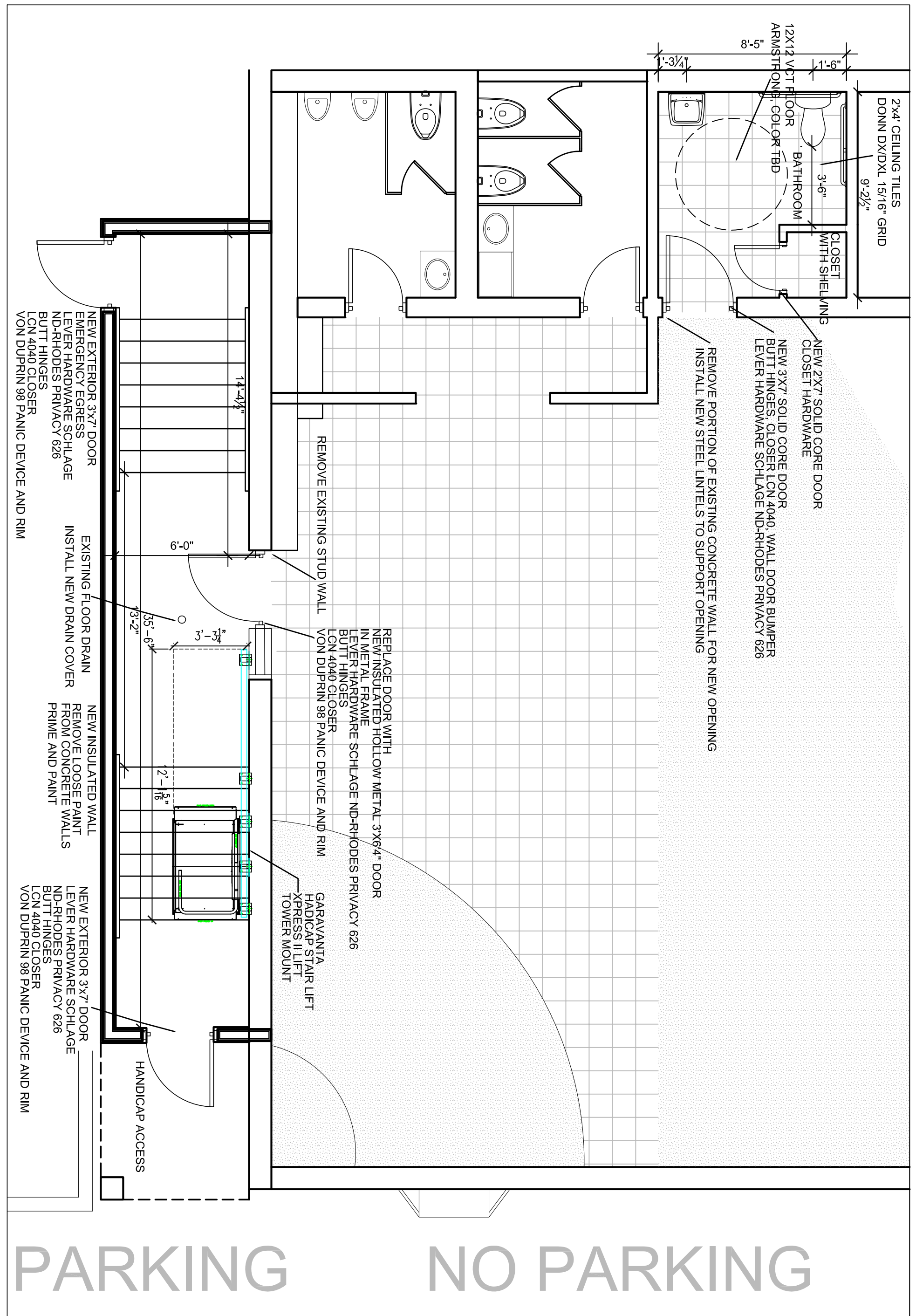

Issued
12.17.12

Project Name
VFW POST 2152
210 FELTON ST
WALTHAM, MA

Drawing Title
PLAN

Scale
1/4"=1'
Sheet Number

A1

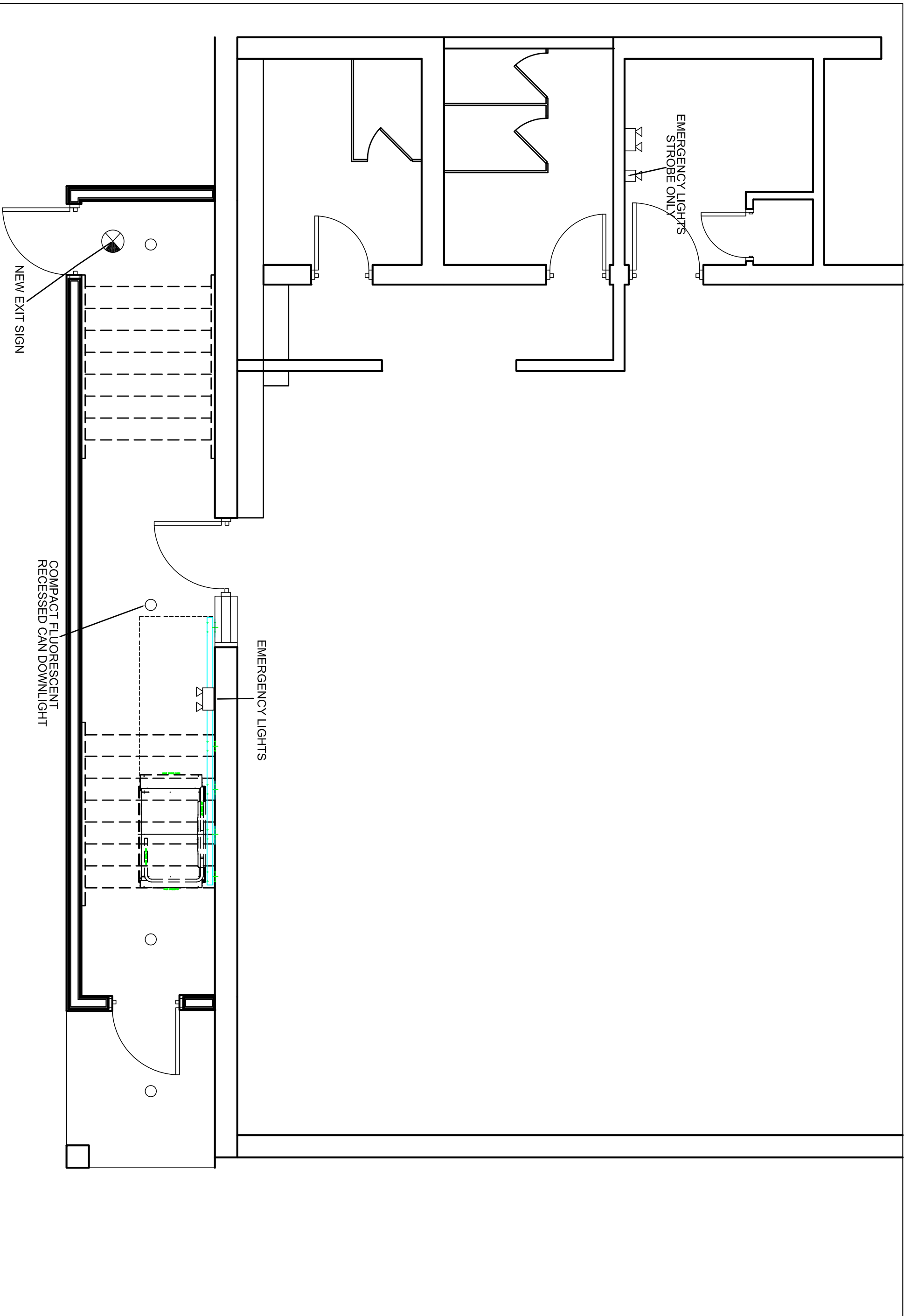

Issued
12.17.12

Project Name
VFW POST 2152
210 FELTON ST
WALTHAM, MA

Drawing Title
CEILING PLAN

Scale
1/4"=1'
Sheet Number

A2

RUBBER MEMBRANE ROOF

3" INSULATION

2 LAYERS 3/4" PLYWOOD

5/8" GWB

COMPACT FLUORESCENT
RECESSED CAN DOWNLIGHT

FIX WINDOW INFILL
BLOCKS ARE SLIPPING

1-1/2" DIA RAILINGS

POWER REQUIREMENTS FOR LIFT:
208-240 VAC, 50/60 HZ SINGLE PHASE
ON A DEDICATE 20 AMP CIRCUIT

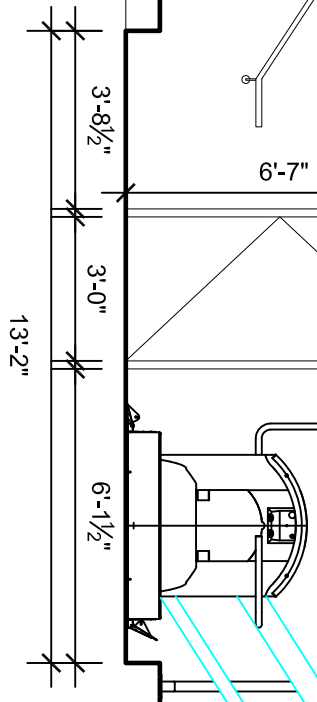

EXISTING CONDITIONS

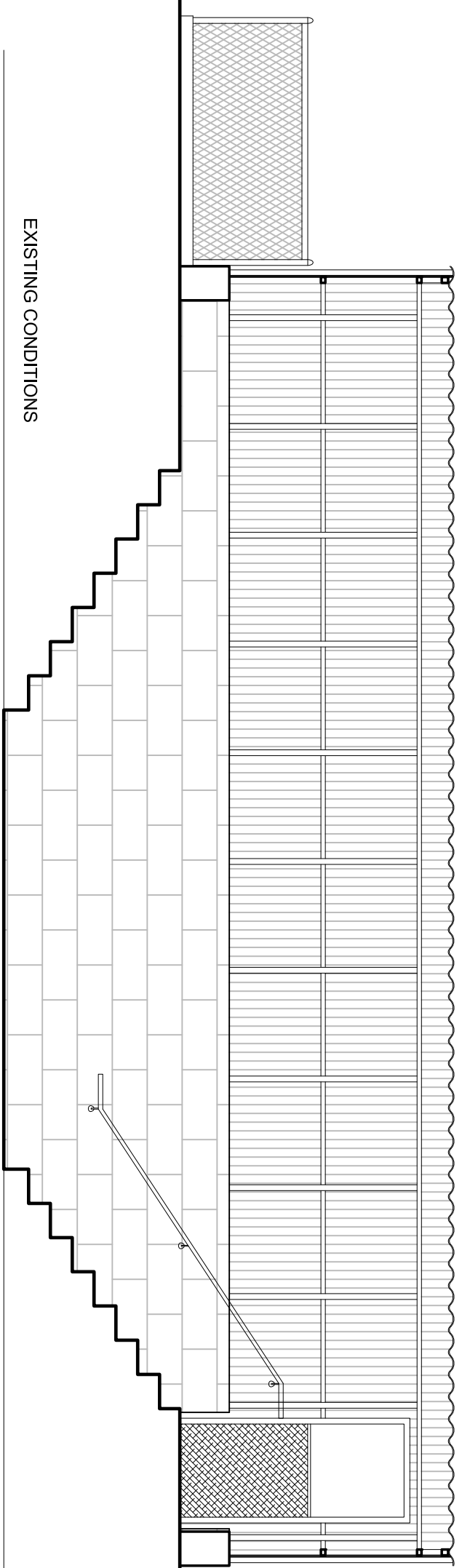

Issued
12.17.12

Project Name
VFW POST 2152
210 FELTON ST
WALTHAM, MA

Drawing Title
STAIRWAY
ELEVATIONS

Scale
1/4"=1'
Sheet Number

A3

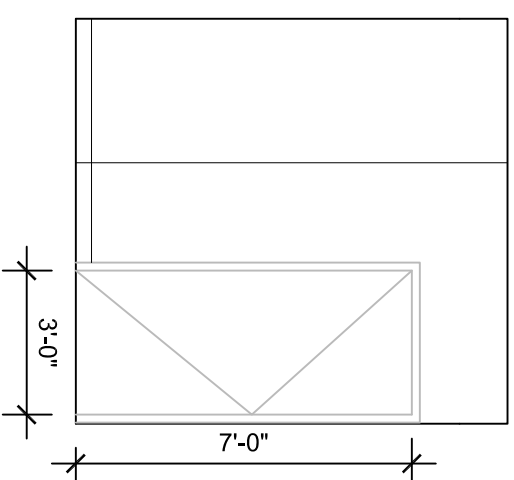
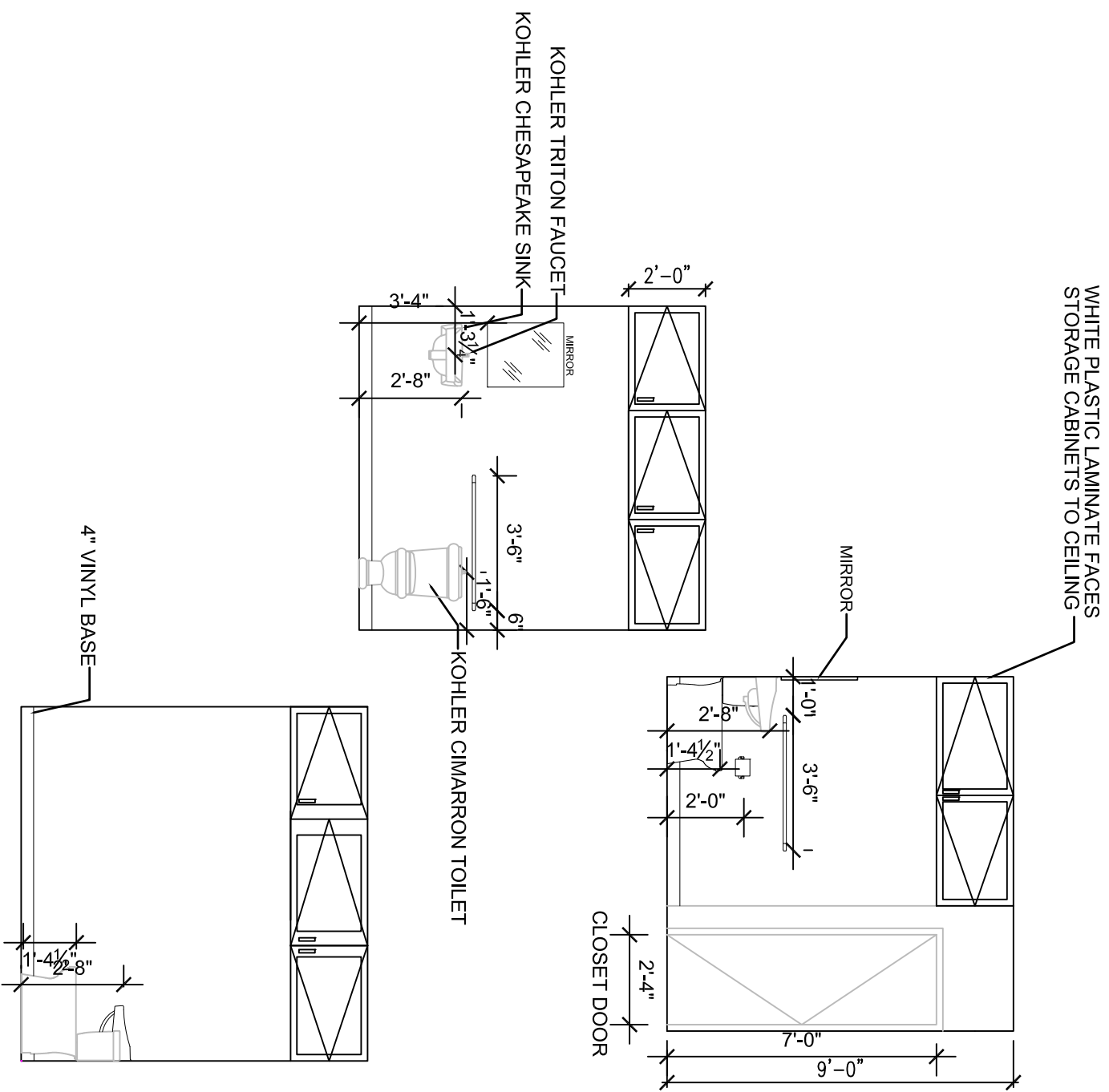

Issued
12.17.12

Project Name
VFW POST 2152
210 FELTON ST
WALTHAM, MA

Drawing Title
BATHROOM
ELEVATIONS

Scale
1/4"=1'
Sheet Number

A4

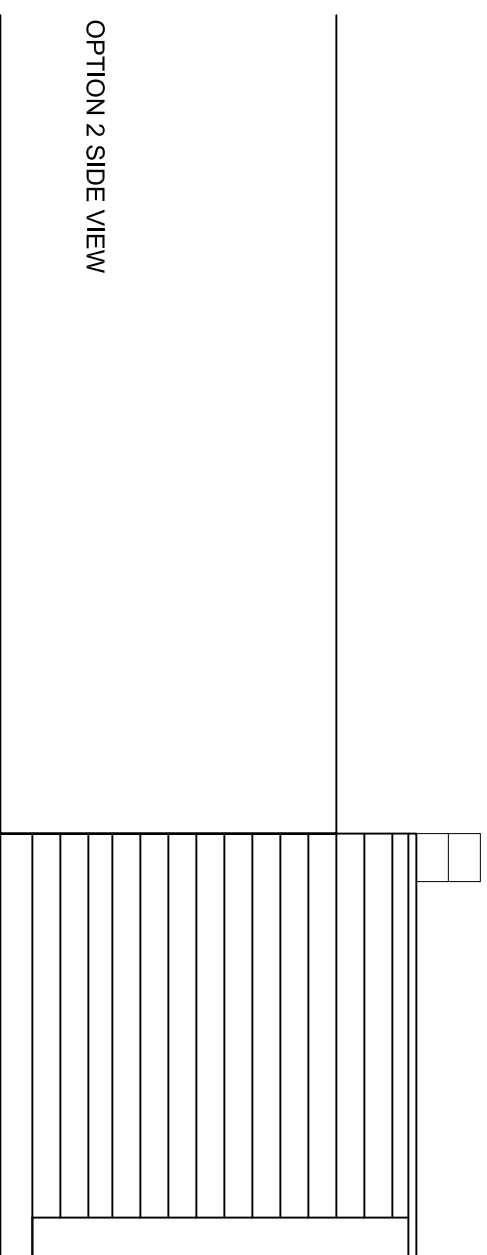
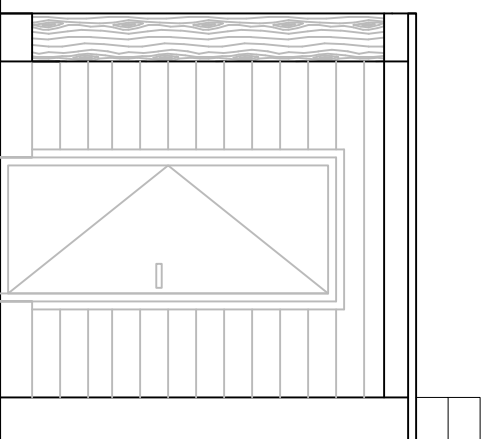
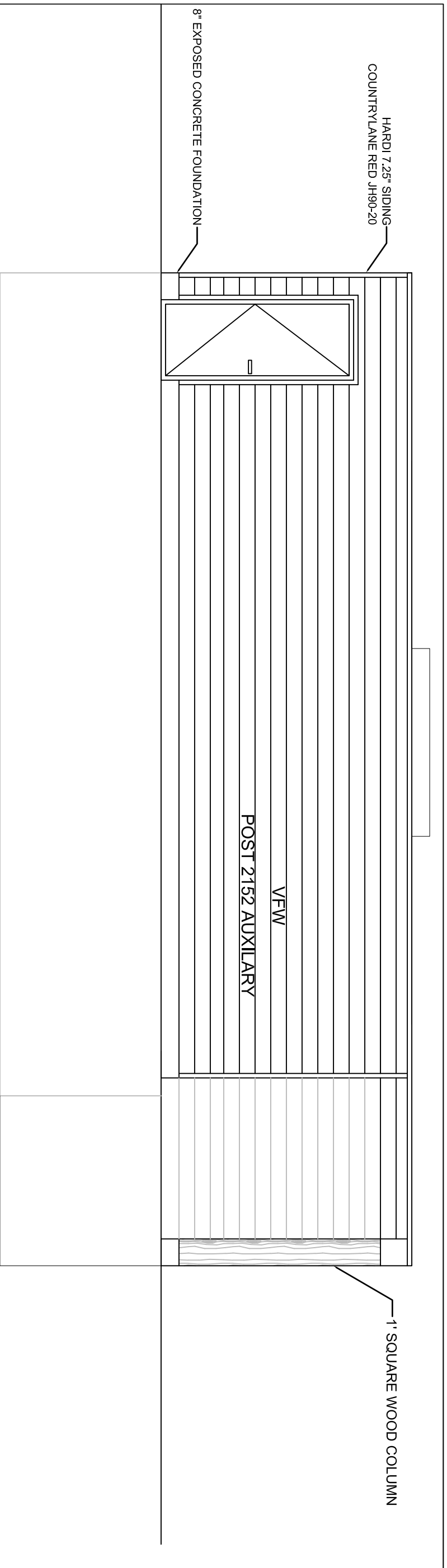

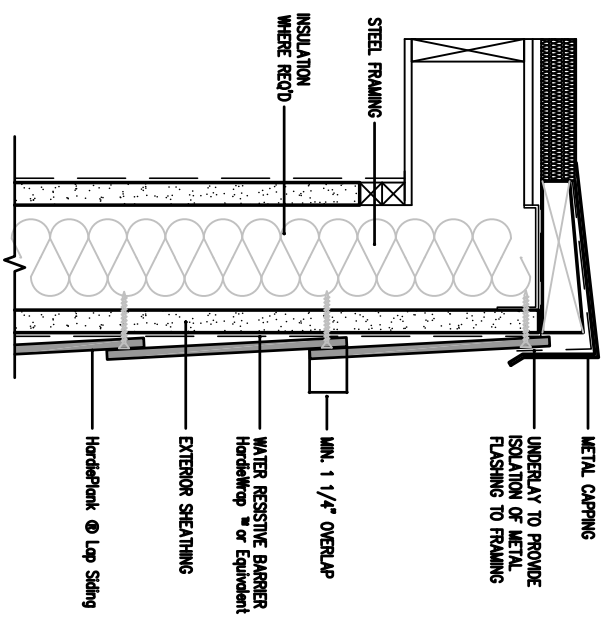

9 PARAPET
SCALE: 3/8"=1'-0"

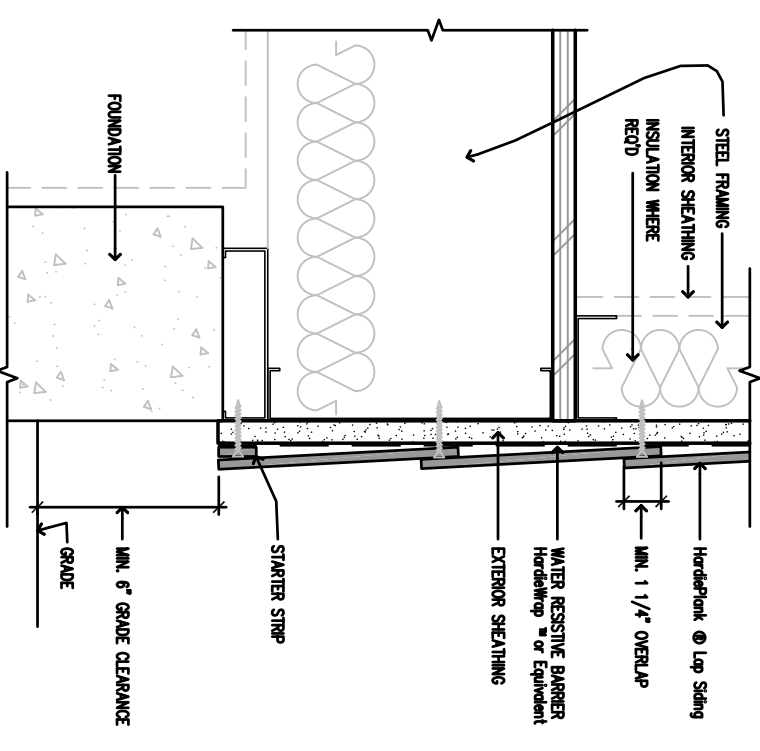

6 GRADE CLEARANCE
SCALE: 3/8"=1'-0"

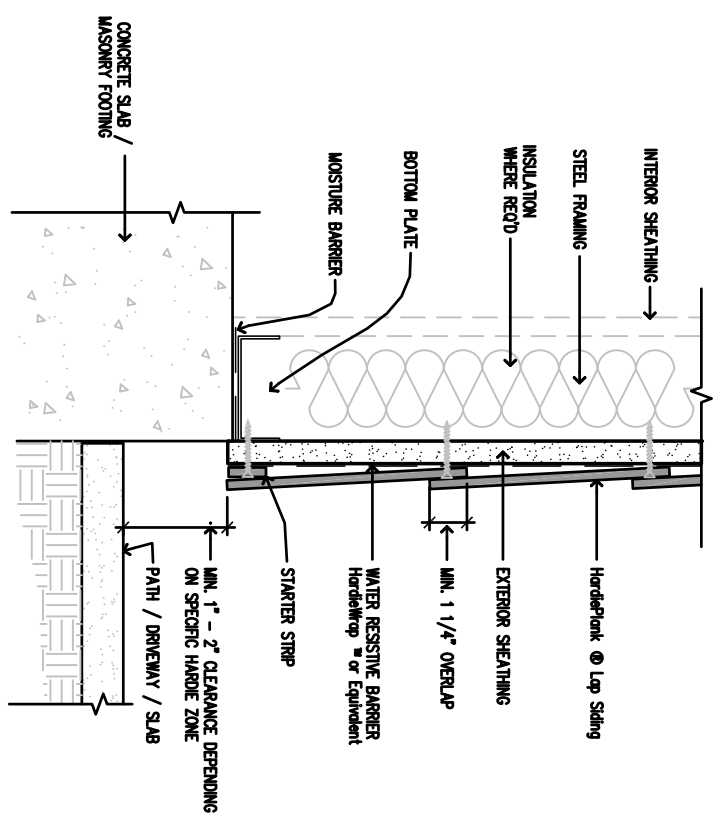

8 HARDSCAPE CLEARANCES, DECKS, PORCHES, PATIOS, WALKWAYS, ROOFS, ETC.
SCALE: 1/2"=1'-0"

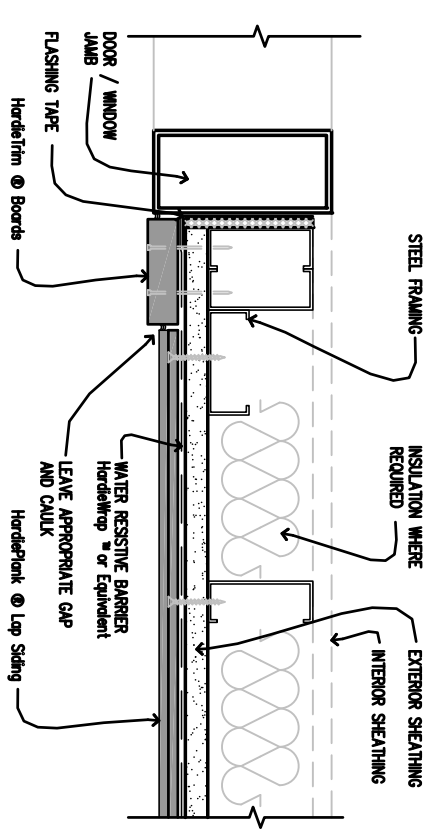

10 DOOR / WINDOW JAMB
SCALE: 3/8"=1'-0"

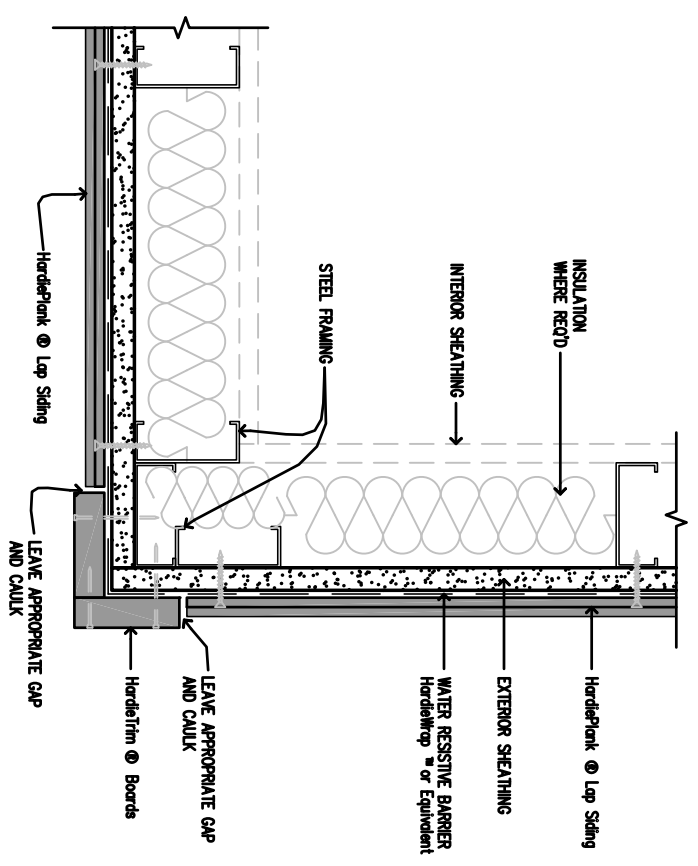

2 OUTSIDE CORNER
SCALE: 3/8"=1'-0"